

INSTRUCTION SHEET

OFF VEHICLE CARBURETOR SERVICE

HOLLEY - MODELS 3160, 4150 4160

50-312-1

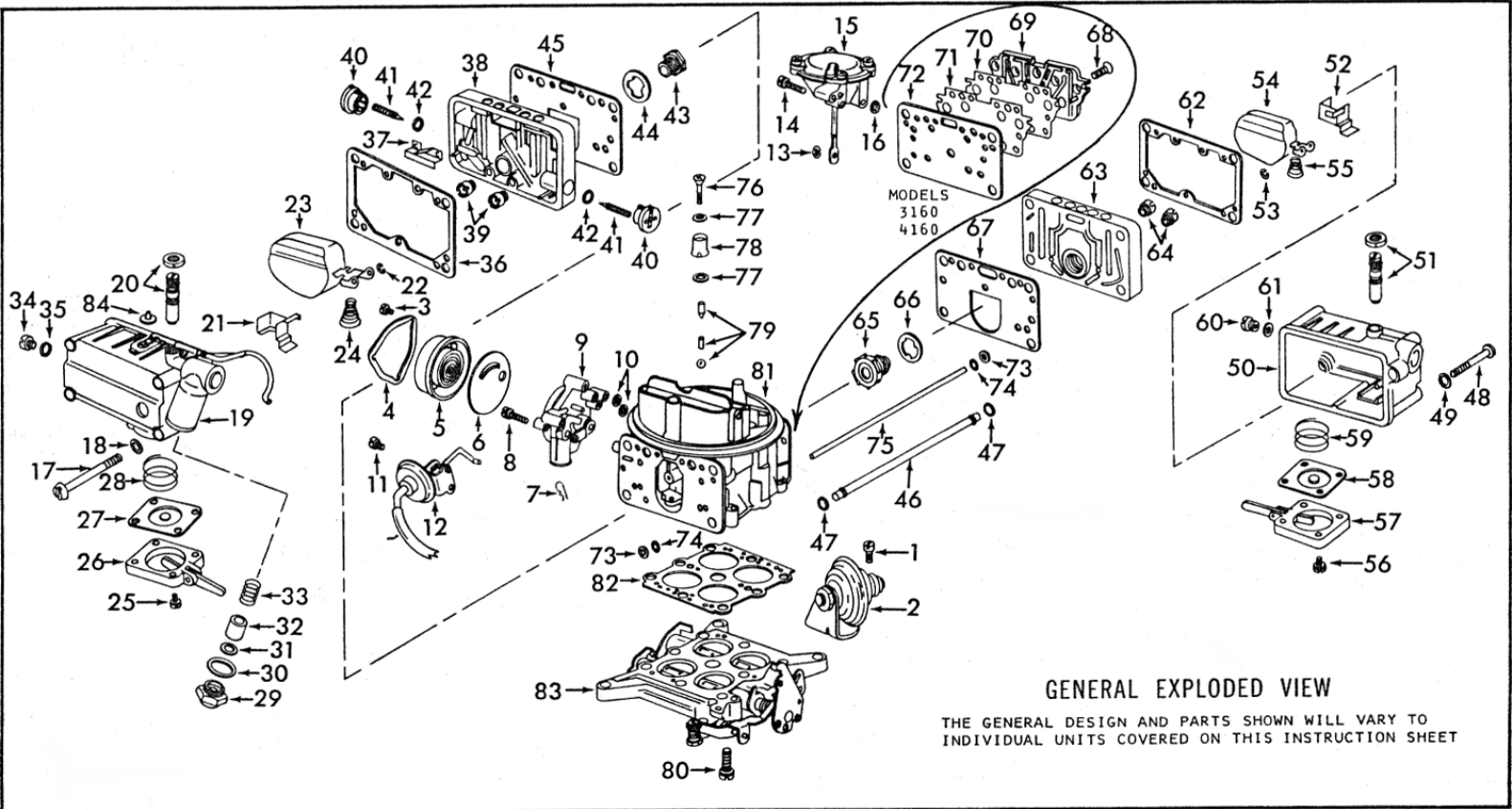

GENERAL EXPLODED VIEW

THE GENERAL DESIGN AND PARTS SHOWN WILL VARY TO
INDIVIDUAL UNITS COVERED ON THIS INSTRUCTION SHEET

NOMENCLATURE

REF. NO.	REF. NO.
1. SCREW & LOCKWASHER - DASHPOT	41. NEEDLE (2) - IDLE ADJ.
2. DASHPOT & BRACKET ASSY.	42. SEAL (2) - IDLE NEEDLE
3. SCREW (3) - COVER CLAMP	43. POWER VALVE - PRI.
4. CLAMP - CHOKE COVER	44. GASKET - POWER VALVE
5. CHOKE COVER & SPRING ASSY.	45. GASKET - PRI. METERING BODY
6. GASKET - CHOKE COVER	46. TUBE - FUEL LINE
7. RETAINER - CHOKE ROD	47. O-RING (2) - TUBE
8. SCREW & LOCKWASHER (3) - CHOKE HOUSING	48. SCREW (4) - SEC. FUEL BOWL
9. CHOKE HOUSING ASSY.	49. GASKET (4) - SEC. BOWL SCREW
10. GASKET - CHOKE HOUSING	50. BOWL - SEC. FUEL
11. SCREW & LOCKWASHER (2) - CHOKE DIAPHRAGM ASSY.	51. NEEDLE & SEAT ASSY. - SEC.
12. CHOKE DIAPHRAGM ASSY. (SOME MODELS)	52. BAFFLE PLATE - SEC. N/S
13. RETAINER - SEC. DIAPHRAGM LINK	53. RETAINER - SEC. FLOAT
14. SCREW & LOCKWASHER (3) - DIAPH. HOUSING ASSY.	54. FLOAT ASSY. - SEC.
15. DIAPH. HOUSING ASSY. - SECONDARY THROTTLE	55. SPRING - SEC. FLOAT
16. GASKET - SEC. DIAPH. HOUSING	56. SCREW & LOCKWASHER (4) - PUMP COVER
17. SCREW (4) - PRI. FUEL BOWL	57. PUMP COVER ASSY. - (HI. PERF. CARB.)
18. GASKET (4) - PRI. BOWL SCREW	58. PUMP DIAPHRAGM ASSY. - (HI. PERF.)
19. BOWL - PRI. FUEL	59. SPRING - PUMP
20. NEEDLE & SEAT ASSY. - PRI.	60. PLUG - SIGHT LEVEL
21. BAFFLE PLATE - PRI. N/S	61. GASKET - PLUG
22. RETAINER - PRI. FLOAT	62. GASKET - SEC. FUEL BOWL
23. FLOAT ASSY. - PRI.	63. METERING BODY - SEC.
24. SPRING - PRI. FLOAT	64. JET (2) - SEC. MAIN
25. SCREW & LOCKWASHER (4) - PUMP COVER	65. POWER VALVE - SEC. (SOME MODELS) OVERRUN VALVE ON TRUCKS STAMPED 215
26. PUMP COVER ASSY.	66. GASKET - VALVE
27. PUMP DIAPHRAGM ASSY.	67. GASKET - SEC. METERING BODY
28. SPRING - PUMP	68. SCREW (6) - SEC. METERING BODY
29. FITTING - FUEL INLET	69. METERING BODY - SEC.
30. GASKET - FITTING	70. GASKET - SEC. METERING BODY PLATE
31. GASKET - FILTER	71. PLATE - SEC. METERING BODY
32. FILTER - FUEL	72. GASKET - SEC. METERING BODY
33. SPRING - FILTER	73. WASHER (2) - BALANCE TUBE (4160)(3160)
34. PLUG - SIGHT LEVEL	74. O-RING (2) - BALANCE TUBE (4160)(3160)
35. GASKET - PLUG	75. BALANCE TUBE (4160)(3160)
36. GASKET - PRI. FUEL BOWL	76. SCREW - PUMP DISC. NOZZLE
37. VENT BAFFLE - METERING BODY	77. GASKET (2) - PUMP DISC. NOZZLE
38. METERING BODY - PRI.	78. NOZZLE - PUMP DISC.
39. JET (2) - PRI. MAIN	79. NEEDLE VALVE - PUMP DISC. (OR BALL AND WEIGHT)
40. CAP (2) - IDLE LIMITER (SOME MODELS)	80. SCREW & LOCKWASHER (8) - THROTTLE BODY
	81. MAIN BODY ASSY.
	82. GASKET - THROTTLE BODY
	83. THROTTLE BODY ASSY.
	84. AIR VENT VALVE OR CAP

DISASSEMBLY

USE EXPLODED VIEW AS A GUIDE. THE NUMERICAL SEQUENCE MAY GENERALLY BE FOLLOWED TO DISASSEMBLE UNIT FAR ENOUGH TO PERMIT CLEANING AND INSPECTION. NOTE: PRIMARY SIDE (CHOKE SIDE) AND SECONDARY SIDE PARTS ARE NOT ALWAYS IDENTICAL. BE SURE TO MARK PARTS TAKEN FROM PRIMARY SIDE. SECONDARY THROTTLE DIAPHRAGM ASSY. (15) - IF TAKEN APART BE CAREFUL NOT TO TEAR DIAPHRAGM WHEN TAKING OUT OR INSTALLING COVER SCREWS.

CLEANING

CLEANING MUST BE DONE WITH CARBURETOR DISASSEMBLED. SOAK PARTS LONG ENOUGH TO SOFTEN AND REMOVE ALL FOREIGN MATERIAL. USE A CARBURETOR CLEANING SOLVENT. MAKE CERTAIN THE THROTTLE BORES ARE FREE OF ALL CARBON AND VARNISH DEPOSITS. RINSE OFF IN SUITABLE SOLVENT. BLOW OUT ALL PASSAGES IN CASTINGS WITH COMPRESSED AIR AND CHECK CAREFULLY TO INSURE THOROUGH CLEANING OF OBSCURE AREAS. CAUTION: DO NOT SOAK PARTS WITH ATTACHED PLASTIC PARTS FOR A LONG PERIOD OF TIME. DO NOT SOAK ANY PARTS CONTAINING RUBBER OR DIAPHRAGM ASSEMBLIES.

REASSEMBLY

REASSEMBLE IN REVERSE ORDER OF DISASSEMBLY. NOTE SPECIAL INSTRUCTIONS AND FOLLOW NUMERICAL OUTLINE IN MAKING ADJUSTMENTS NECESSARY FOR CARBURETOR BEING SERVICED.

SPECIAL INSTRUCTIONS

THROTTLE BODY GASKET (82) - BE SURE HOLES ARE PROPERLY MATCHED TO THROTTLE BODY

POWER VALVE INSTALLATION

SOME KIT APPLICATIONS - PRI. & SEC. VALVES ARE THE SAME. SOME KIT APPLICATIONS - PRI. SIDE, USE THE VALVE WITH THE SMALLEST IDENTIFYING NUMBER. (STAMPED ON SIDE OF VALVE.)
SPECIAL NOTE: HI. PERF. CARB.
CARB. NO. R4778AAA PRI. 8.5 SEC. NONE
R4779AAA PRI. 8.5 SEC. NONE
R4780AAA PRI. 6.5 SEC. 8.5

IDLE ADJ. NEEDLES (41) - TURN IN UNTIL LIGHTLY SEATED THEN BACK OUT 1" TURN. (DO NOT INSTALL IDLE LIMITER CAPS AT THIS TIME WHEN USED.)
NOTE: SOME LATE CARBURETORS HAVE A "BACKWARDS" IDLE ADJUSTMENT, TURN NEEDLES IN TO RICHEN THE MIXTURE, BACK NEEDLES OUT TO LEAN THE MIXTURE.

PRI. & SEC. FUEL BOWL - BEFORE INSTALLING MAKE DRY FLOAT LEVEL ADJUSTMENT.

O-RINGS - LUBRICATE LIGHTLY BEFORE INSTALLING.

ADJUSTMENTS

SIDE HUNG FLOAT

CENTER HUNG FLOAT

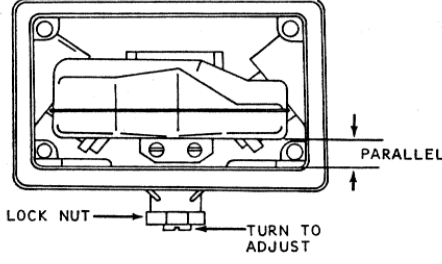
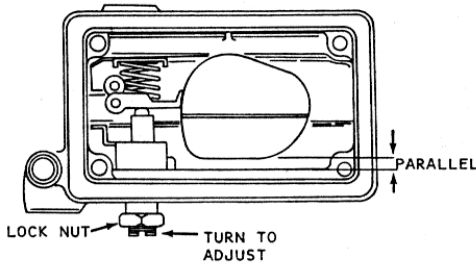

LOCK NUT → TURN TO ADJUST
 FLOAT BOWL INVERTED, TURN NEEDLE SEAT ASSY. UNTIL FLOAT SURFACE IS PARALLEL WITH THE SURFACE DIRECTLY BELOW THE FLOAT. TIGHTEN LOCK NUT.

LOCK NUT → TURN TO ADJUST
 FLOAT BOWL INVERTED, TURN NEEDLE SEAT ASSY. UNTIL FLOAT SURFACE IS PARALLEL WITH THE SURFACE DIRECTLY BELOW THE FLOAT. TIGHTEN LOCK NUT.

DRY FLOAT LEVEL ADJUSTMENTS
 FIG. 1

FIG. 2

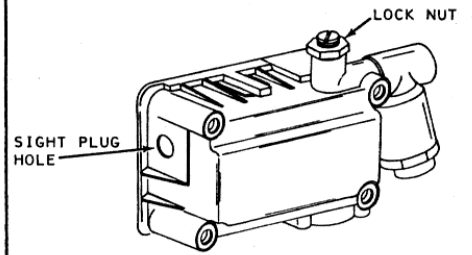

1. CAR SETTING ON LEVEL SURFACE & ENGINE RUNNING.
2. REMOVE SIGHT LEVEL PLUG FROM BOWL.
3. ADJUST NEEDLE SEAT ASSY. SO FUEL LEVEL WILL BE AT BOTTOM EDGE OF SIGHT PLUG HOLE. (PLUS OR MINUS 1/32" TOLERANCE.)
4. TIGHTEN LOCK NUT.

WET FLOAT LEVEL ADJUSTMENT FIG. 3

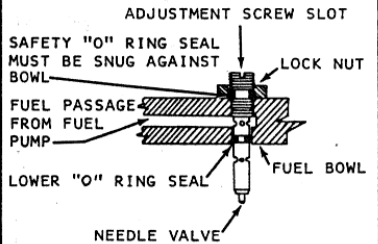

THE EXCLUSIVE SEALING FEATURES OF THIS ASSEMBLY PROVIDE SAFE ADJ. OF FUEL LEVEL WHILE ENGINE IS RUNNING.

SAFETY SEAL ADJUSTABLE FUEL VALVE
 FIG. 4

TRUCK APPLICATIONS TUBE IS EQUALLY PROJECTED IN BOTH PRIMARY AND SECONDARY BOWLS.

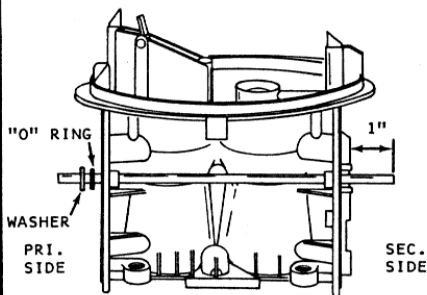

PASSENGER CARS TUBE IS PROJECTED 1 INCH FROM SECONDARY METERING BODY.

BALANCE TUBE POSITION FIG. 5

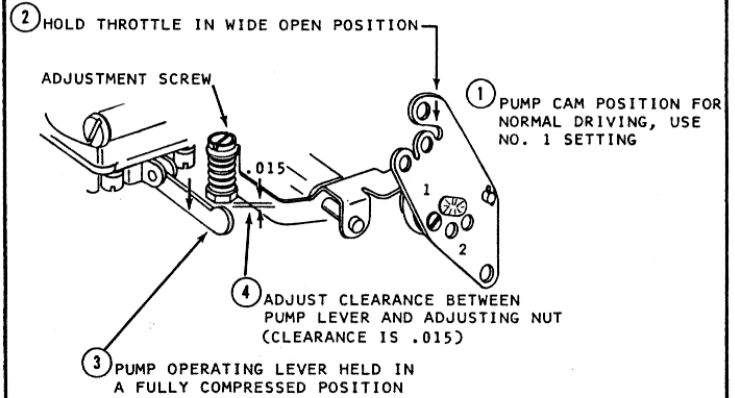

PRI. & SEC. PUMP ADJUSTMENT

FIG. 6

THROTTLE VALVES FULLY CLOSED, MEASURE DISTANCE BETWEEN VENT VALVE AND SEAT.

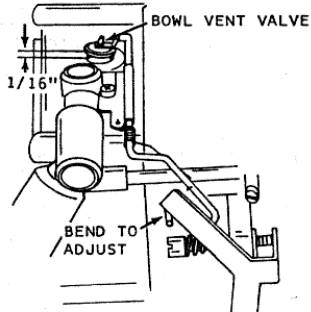

BOWL VENT ADJUSTMENT FIG. 7

ALIGN MARK ON STAT COIL WITH INDEX ON CHOKE HOUSING. ALLOWABLE VARIATIONS, 2 MARKS EITHER WAY FROM INDEX.

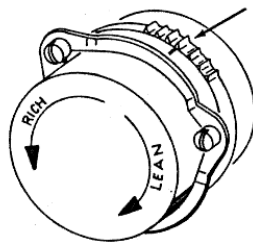

AUTOMATIC CHOKE SETTING FIG. 8

CHOKE HELD TOWARD CLOSED POSITION, MEASURE BETWEEN UPPER EDGE OF CHOKE VALVE AND AIR HORN WALL.

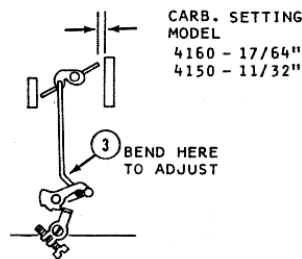

○ THROTTLE HELD WIDE OPEN

UNLOADER ADJUSTMENT FIG. 9

SECONDARY THROTTLE STOP SCREW, BACK OUT UNTIL SECONDARY THROTTLE PLATES ARE CLOSED. TURN SCREW IN UNTIL IT CONTACTS STOP, THEN TURN SCREW IN 1/2 - 3/4 TURNS MORE.

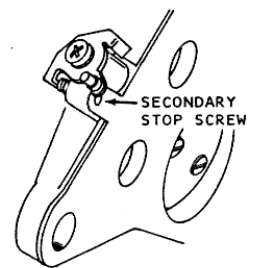

SECONDARY THROTTLE STOP ADJUSTMENT

FIG. 10

1 OPEN THROTTLE TO CLEAR FAST IDLE CAM.

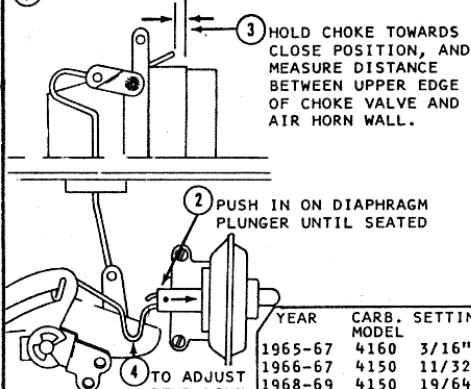

VACUUM BREAK ADJUSTMENT. FIG. 11

ENGINE AT OPERATING TEMP. AND CHOKE WIDE OPEN, ADJUST IDLE MIXTURE NEEDLES TO A SMOOTH IDLE. ADJUST IDLE STOP SCREW TO 500-550 R.P.M. OR FOLLOW SETTING ON ENGINE DECAL.

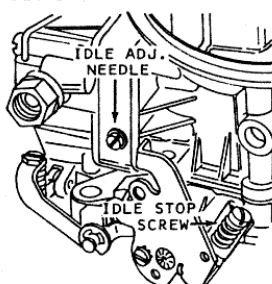

SLOW IDLE ADJUSTMENT FIG. 12

PLACE FAST IDLE SCREW ON HIGH STEP OF FAST IDLE CAM AND SET TO 1600-1800 R.P.M. OR FOLLOW SETTING ON ENGINE DECAL.

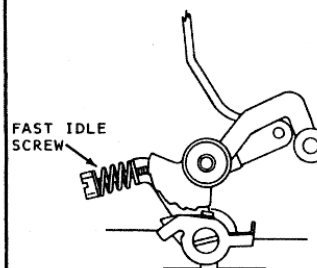

FAST IDLE ADJUSTMENT FIG. 13

2 DEPRESS PLUNGER STEM AND MEASURE DISTANCE BETWEEN END OF STEM AND THROTTLE ARM.

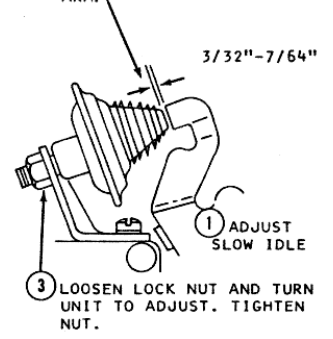

3 LOOSEN LOCK NUT AND TURN UNIT TO ADJUST. TIGHTEN NUT.

(DASHPOT)
 SLOW CLOSING THROTTLE ADJ.
 FIG. 14